

# From First Sheet to Final Bolt



COMPONENT PRODUCTS BUYER'S GUIDE

**MUELLER**

# We Understand Your Big Picture

## Honest Dedication

Our craftsmen know the work and challenges that come with manufacturing tanks; they know the process inside and out, up and down. What is important to you is important to them, and you can be sure that tank components made by our experienced fabricators are carefully crafted down to the last detail.

This Component Products Buyer's Guide is your one-stop shop for standard parts as well as complex custom parts for building or refurbishing your tank to your exact specifications.



# We Have Your Solution

- Clear Communication
- Accurate Engineering
- Uncompromised Quality
- Competitive Lead Times

Once we have carefully crafted your tank components, we can ship them directly to your door. Our transportation team can deliver the largest component pieces you can dream up, all while keeping them in pristine condition.

As your tank comes to life, Paul Mueller Company can help you acquire all the components you need to keep your production on time and on budget.

**Check out our easy online order platform to keep your project organized and your parts in stock.**

[shop.paulmueller.com](http://shop.paulmueller.com)



## TABLE OF CONTENTS

We Understand Your Big Picture . . . . .	1
Guide to Buying:	
Tank Heads . . . . .	3
Tank Cylinders . . . . .	4
Mixers . . . . .	5
Manways . . . . .	7
Tank Parts . . . . .	8
Heat Transfer Buying Information. . . . .	9
Capabilities . . . . .	10
Material Finishes . . . . .	11
Weld Finishes . . . . .	12
Anatomy of a Dished and Flanged Head . . . . .	13
Anatomy of a Conical Head. . . . .	14
Anatomy of a Cylinder . . . . .	15
Tolerances and Allowances . . . . .	16
Mueller® Component Products FAQs. . . . .	19
Notes . . . . .	21

# Guide to Buying Tank Heads



## DISHED AND CONICAL HEADS

### Quote Checklist

- Quantity
- Inside/Outside
- Material Type
- Minimum Thickness
- X-Ray
- Preferred Bevel
- Head Style
- Diameter
- Material Thickness
- ASME Code
- Material Finish

### NEED HEAT TRANSFER?



REVIEW MUELLER COMPONENT PRODUCTS HEAT TRANSFER OPTIONS (SEE PAGE 7).



WORK WITH THE MUELLER SALES TEAM TO DETERMINE SPECIFICATIONS.



ADD TO YOUR MUELLER COMPONENT PRODUCTS ORDER.

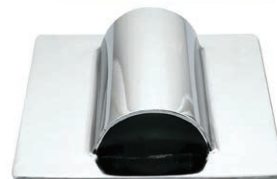
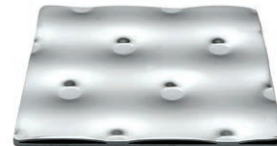

# Guide to Buying Tank Cylinders



## CYLINDERS AND SHELLS

### Quote Checklist

- Quantity
- Height
- Material Type
- Minimum Thickness
- X-Ray
- Bevel
- Diameter
- Width
- Material Thickness
- ASME Code
- Material Finish

## NEED AN AGITATION OR MIXING SYSTEM?



DOWNLOAD THE AGITATION DATA FORM AT:  
[PAULMUELLER.COM/AGITATIONDATA](http://PAULMUELLER.COM/AGITATIONDATA)



WORK WITH THE MUELLER SALES TEAM TO  
DETERMINE SPECIFICATIONS.



ADD TO YOUR MUELLER COMPONENT PROD-  
UCTS ORDER.



# Guide to Buying Mixers



Mueller Mixers are a perfect match for all of your sanitary mixing applications, including pharmaceutical, cosmetic, food, and beverage. We back the quality of our mixers with the Mueller name and that is something we have stood behind since 1940.

Our Mueller Mixers feature more straight-grade 316 stainless steel than virtually any competitive product line for years of durable service in cGMP environments. Plus, our mechanical seals feature low-noise silicon carbons for quieter operation.

## COMPETITIVE 18-MONTH WARRANTY

- AMERICAN-MADE
- ENGINEERING SUPPORT
- CUSTOM SPECIFICATIONS AVAILABLE
- DOCUMENTATION PACKAGE INCLUDED IN PRICE
- EXCEEDINGLY QUIET
- INDUSTRY-BEST LEAD TIMES



# One-Stop Shop for Component Parts

Every mixing application is unique with different needs for agitation level, shear, suspension, and many other factors. If you need help deciding the best mixer for your specific application, trust Paul Mueller Company's 75 years of engineering expertise. Contact us for a consultation. We can provide custom configurations according to your needs as well.

## MUELLER TOP-MOUNT MIXERS

Direct-Driven (FOR TANKS UP TO 750L)	Model	Tank Volume* (U.S. Gallons/Liters)	Motor Type*	Motor Voltage	Motor HP	Speed (RPM)	Exp. Shaft (Inches)	Impeller (Size/Type)
	AD075-E3	75/285	Air	----	¾	300-3,000	¾" x 30"	(2) 4" Propellers
	AD150-E3	125/475	Air	----	1½	300-3,000	1" x 36"	(2) 5" Propellers
	AD400-E3	200/750	Air	----	4	300-3,000	1" x 42"	(2) 6" Propellers
	END025-E3	30/115	TENV	230/460	¼	1,750	⅝" x 26"	(1) 4" Propeller
	END050-E3	50/190	TENV	230/460	½	1,750	⅝" x 28"	(1) 4.5" Propeller
	END075-E3	75/285	TENV	230/460	¾	1,750	¾" x 30"	(1) 5" Propeller
	END100-E3	100/380	TENV	230/460	1	1,750	¾" x 34"	(1) 5.5" Propeller

Gear-Driven (FOR TANKS UP TO 10,000L)	Model	Tank Volume* (U.S. Gallons/Liters)	Motor Type*	Motor Voltage	Motor HP	Speed (RPM)	Exp. Shaft (Inches)	Impeller (Size/Type)
	AG075-E3	100/380	Air	----	¾	30-300	1" x 32"	10" Hydrofoil
	AG150-E3	500/1,900	Air	----	1½	30-300	1¼" x 48"	16" Hydrofoil
	AG400-E3	500/3,800	Air	----	4	30-300	1½" x 58"	20" Hydrofoil
	ENG025-E3	300/1,135	TEFC	230/460	¼	175	1" x 40"	16" Hydrofoil
	ENG050-E3	500/1,900	TEFC	230/460	½	175	1¼" x 48"	18" Hydrofoil
	ENG075-E3	1,000/3,800	TEFC	230/460	¾	175	1½" x 66"	21" Hydrofoil
	ENG100-E3	1,500/5,700	TEFC	230/460	1	175	1½" x 72"	22" Hydrofoil

Mueller Top-Mount Mixers with external seals are designed for the most stringent sanitary applications. All-stainless construction provides maximum protection against corrosion and cleaning solutions. We also offer direct- and gear-driven Mueller Top-Mount Mixers with internal seals that can be configured to meet application requirements including variable speed, alternate impellers, and many more options.

\*Reference tank volumes. Mixers configured for moderate agitation of "water-like" materials. Contact us for assistance with higher viscosities.

\*Explosion-proof motors are available upon special request.

# Guide to Buying Manways



## MANWAYS

1. Visit [shop.paulmueller.com](http://shop.paulmueller.com) for all your manway needs.
2. Determine pressure, temperature, ASME/non-code, and size requirements.
3. Call your Mueller Sales Representative with your questions at 1-800-545-5224.
4. Enjoy lifetime support from our responsive team.



### ROUND

Available in a variety of sizes for horizontal or vertical applications. We offer pressure-rated manways with ASME Code or PED compliance as well as atmospheric options. Additional accessories such as spring assists, lift assists, or sanitary fittings can be added.



### OVAL

Available in a variety of sizes ideal for horizontal applications. The manway doors on these assemblies consist of an in-swing/out-swing design that allows for easy access to the vessel. Pressure- and vacuum-rated manways with ASME Code or PED compliance, as well as atmospheric options are offered.

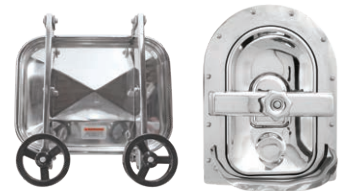

### RECTANGULAR

Available in a variety of sizes ideal for bottom tank access. This unique shape allows for quicker and more economical cleaning processes to better accommodate the use of shovels. A variety of gasket materials are available for your specific needs.



# Guide to Buying Tank Parts

## TANK PARTS

1. Visit [shop.paulmueller.com](http://shop.paulmueller.com) for all your tank part needs.
2. If replacing parts for Mueller-fabricated equipment, identify your vessel serial number. (See page 18 for assistance on locating serial number.)
3. Call your Mueller Sales Representative with any questions at 1-800-545-5224.
4. Enjoy lifetime support from our responsive team.

### AGITATION ASSEMBLIES



### PROP AND SHAFTS



### GEARMOTORS



### MANWAY ACCESSORIES



### REPLACEMENT PARTS



### CUSTOM TANK PARTS



### SAMPLER ASSEMBLIES



### GASKETS



### TOP-MOUNT MIXERS



FOR MORE INFORMATION ON AVAILABLE TANK PARTS AND MANWAYS VISIT:

[shop.paulmueller.com](http://shop.paulmueller.com)

# Buying Information for Heat Transfer

## Temp-Plate® Heat Transfer

Mueller Temp-Plate is an economical type of heat transfer surface utilized for interior tank walls and tank heads. Single- and double-embossed designs are available for many applications. Temp-Plate provides precise, consistent control capability with minimum pressure drop. Spot-welded and inflated channels induce the necessary fluid turbulence to attain high heat transfer coefficients.

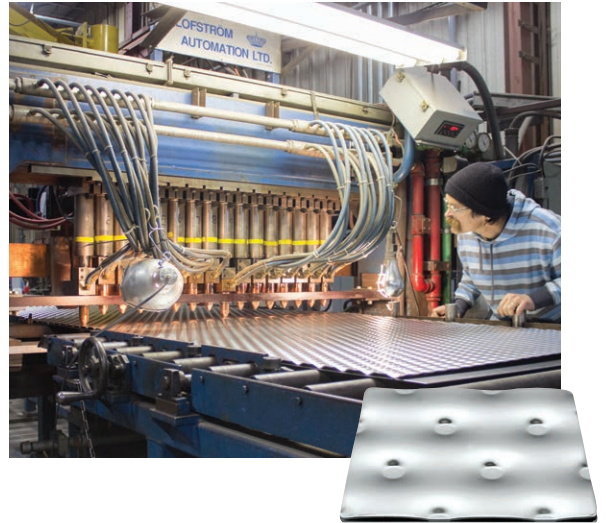

## Half-Pipe Coil

Mueller half-pipe heat transfer handles large volumes of flow and is suited for high pressure applications. It is available in many configurations including half-pipe for heads, shells, and cones. Half-pipe heat transfer can be purchased as a fully welded and tested assembly, a “fit-and-tacked” assembly, or as loose coils.



## Dimpled Heat Transfer

Our dimpled heat transfer surface is ideally suited for applications involving temperature and high pressure extremes. We routinely fabricate custom sizes, shapes, and materials to fit any vessel design. Styles are available for use with almost any type of refrigerant or heating media.



# Component Products Capabilities

## Materials

- Type 304/304L
- Type 316/316L
- Type 317L
- Custom Nickel Alloys
- Monel®
- Inconel®
- Hastelloy®
- 254 SMO®
- Carbon Steel
- Alloy 20
- Copper
- Aluminum
- AL-6XN®
- 904L
- Duplex
- And others

## Head Sizes

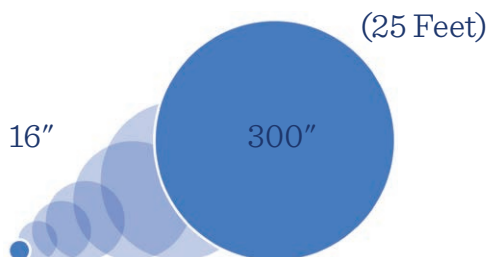

## Material Thickness



## TESTS AND CERTIFICATIONS

**You are putting your name on the tank and Paul Mueller Company is here to support your commitment to quality. We want to help you provide your customer with the best on-time product tested through our stringent in-house quality programs.**

- Our ASME Inspectors are located at Paul Mueller Company's facility. We can comply with other codes as well, such as PED, 3-A, Chinese code, and API 650.
- An on-site radiography team and a full lead-lined vault allows us to perform radiography without field mobilization.
- Do you require an unusual material? Our welding engineering and grinding technology specialists ensure we can find a solution for any of your welding or grinding needs.
- Other quality testing includes dye penetrant, Positive Material Identification (PMI), and ultrasonic material thickness testing.



# Material Finishes

The following finishes are available. Some applications may require a specific finish. For help determining final finish, contact your Mueller Sales Representative.



## HOT ROLLED (HR)

Rough and dull appearance on surface. Most of the scale is removed by pickling. This applies to all steel plate thicknesses  $\frac{3}{16}$ " and above.



## 2B MILL FINISH

A smooth, bright, moderately reflective finish suitable for "as-is" specifications or a preliminary finish for further polishing.



## #3 FINISH

Polished surface achieved by finishing with the equivalent of an 80-grit abrasive. This finish has a pronounced grit line. 75 Ra average.



## #4 FINISH

Bright finish with visible grain for use where sanitary surfaces are required. 35 Ra target. Request 32 Ra maximum finish to comply with 3-A standards.



## #6 FINISH

Polished surface achieved by finishing with the equivalent of a 240-grit abrasive. Higher reflectivity and finer grit lines. Improved product release and cleanability. 25 Ra target.



## #7 FINISH

Highly reflective surface achieved by finishing with the equivalent of a 320-grit abrasive. Minimal grit lines. Used when product contact surfaces are critical. 15 Ra target.



## GARNET-BEAD BLAST

Follows sandblasting to create a satin, gray appearance that resembles a 2B finish.



## RADIAL SPIN POLISH

Spin polishing finishes of preformed, inside, outside, knuckle, and straight flange surfaces in a circular pattern. Results in an appealing sanitary finish.



## CIRCUMFERENTIAL SPIN POLISH

Similar to radial spin polish, further reduces visibility of circular pattern. Results in superior aesthetic finish for high visibility tank heads.

# Weld Finishes

The following weld finishes are available. Certain forming processes require specific finishes. Choose weld finishes with your Mueller Sales Representative during the custom quote step.



## AS-IS

Quality welds are to remain as deposited with no grinding.



## BUFF

Minimal removal of weld material. Welds are not ground flush and may contain crevices, ripples, and irregularities in the remaining weld material.

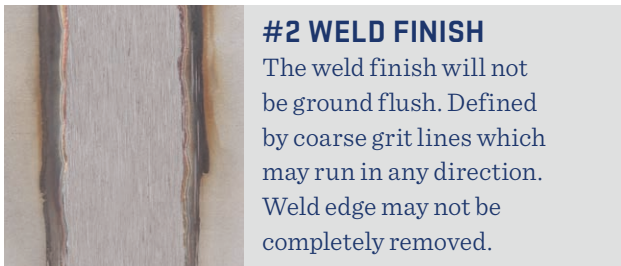

## #2 WELD FINISH

The weld finish will not be ground flush. Defined by coarse grit lines which may run in any direction. Weld edge may not be completely removed.



## #3 WELD FINISH

Welds are ground flush and weld discoloration is removed. Scattered nicks and scratches are acceptable. Ideal where a uniform surface is required.



## #4 WELD FINISH

Normally used with #4 material finish when sanitary product contact surfaces are required. 35 Ra target. Request 32 Ra maximum to comply with 3-A standards.



## #6 WELD FINISH

Characterized by finer grit lines and higher reflectivity than #4 finish. Improved product release, as well as cleanability. 25 Ra target.



## #7 WELD FINISH

A highly reflective and sanitary surface with minimal grit lines. Provides excellent product release, as well as cleanability. 15 Ra target.



## GARNET-BEAD BLAST

Follows sandblasting to create a satin, gray appearance that resembles a 2B finish.



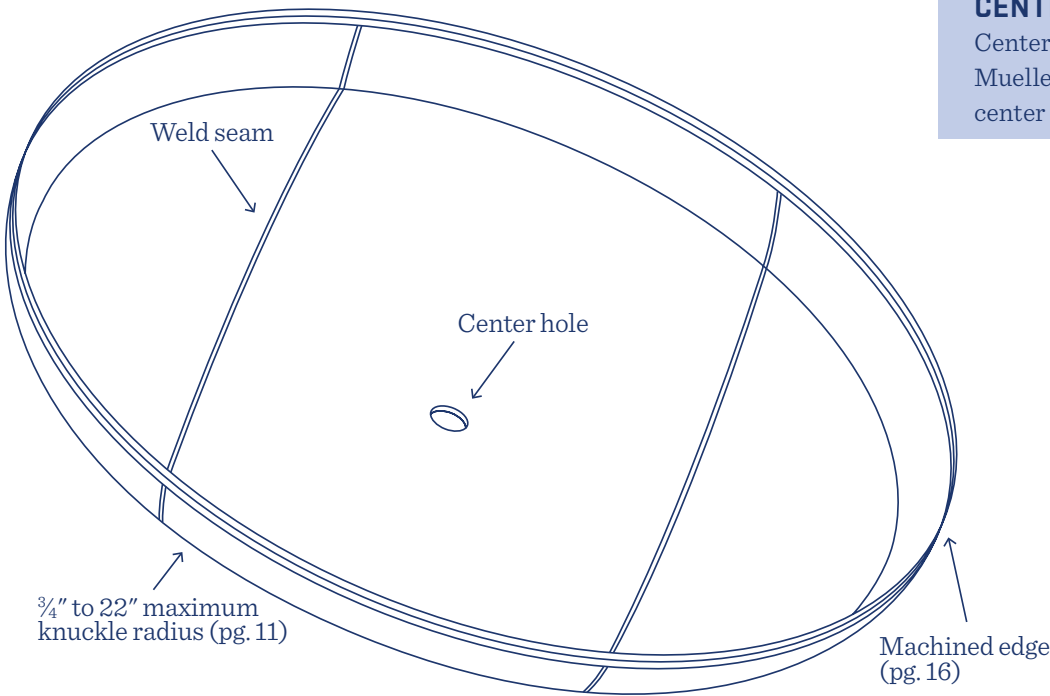

# Anatomy of a Tank Head

## DISHED AND FLANGED TANK HEAD



**CENTER HOLE:**

Center holes are standard; however, Mueller also provides tank heads without center holes.

Typical Head Types	Dish Radius	Knuckle Radius	Diameter	Thickness
 Shallow Flanged and Dished	Equal to 150% of outside diameter.	2"	16"–300"	12 gauge–1"
 Standard Flanged and Dished	Equal to 100% of outside diameter.	2"	16"–300"	12 gauge–1"
 ASME Flanged and Dished	Equal to 100% of outside diameter.	Minimum of 6% outside diameter.	16"–300"	12 gauge–1"
 80/10 Flanged and Dished	80% of outside diameter.	10% of outside diameter.	20"–220"	$\frac{3}{16}$ "–1"
 2:1 Elliptical Flanged and Dished	Approximately 90% of outside diameter.	Approximately 17% of outside diameter.	20"–144"	$\frac{3}{16}$ "–1"
Custom Flanged and Dished	Tank heads are fully customizable to meet your specific applications. Contact your Paul Mueller Company Sales Representative for additional configurations.			

# Anatomy of a Tank Head

## CONICAL TANK HEAD

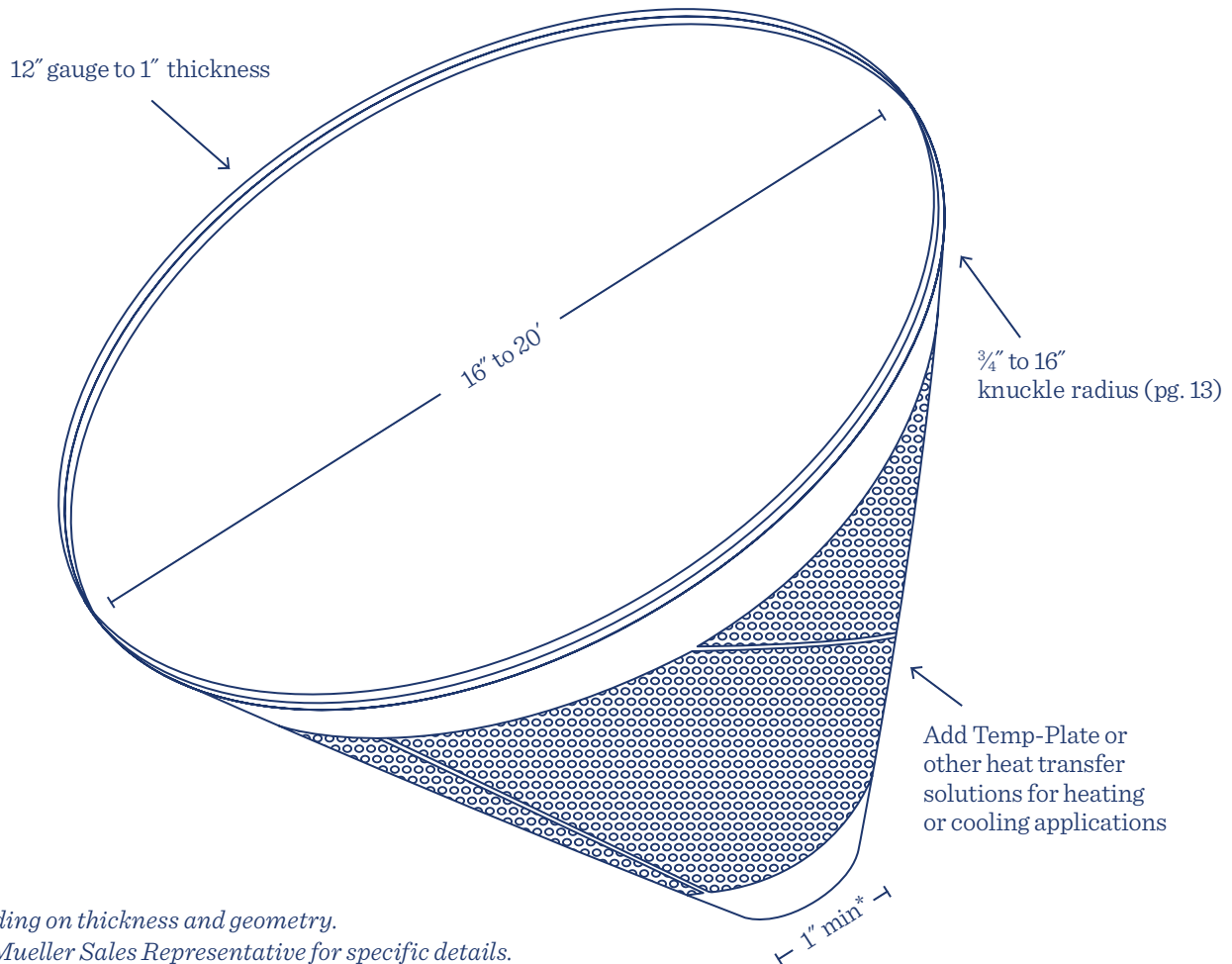

### TOPICS TO REMEMBER



A WIDE RANGE OF MATERIAL FINISHES ARE AVAILABLE (SEE PAGE 11).



CONTACT US FOR MORE INFORMATION ABOUT THE FORMING TECHNIQUES WE USE:

PRESS BRAKE | PULLED | ROLLED



# Anatomy of a Cylinder

Paul Mueller Company’s extensive manufacturing capabilities allow us to build cylinders to almost any specification. Whether you need a cylinder that is too big or too thick for your rolls or are simply having trouble meeting demand and need a little relief, we are here to provide a solution. Our in-house transportation team makes shipping cost-effective. Through expert utilization of jelly-rolling, cradling, and bracing techniques, we can optimize shipping expenses to get your products delivered on time and on budget.

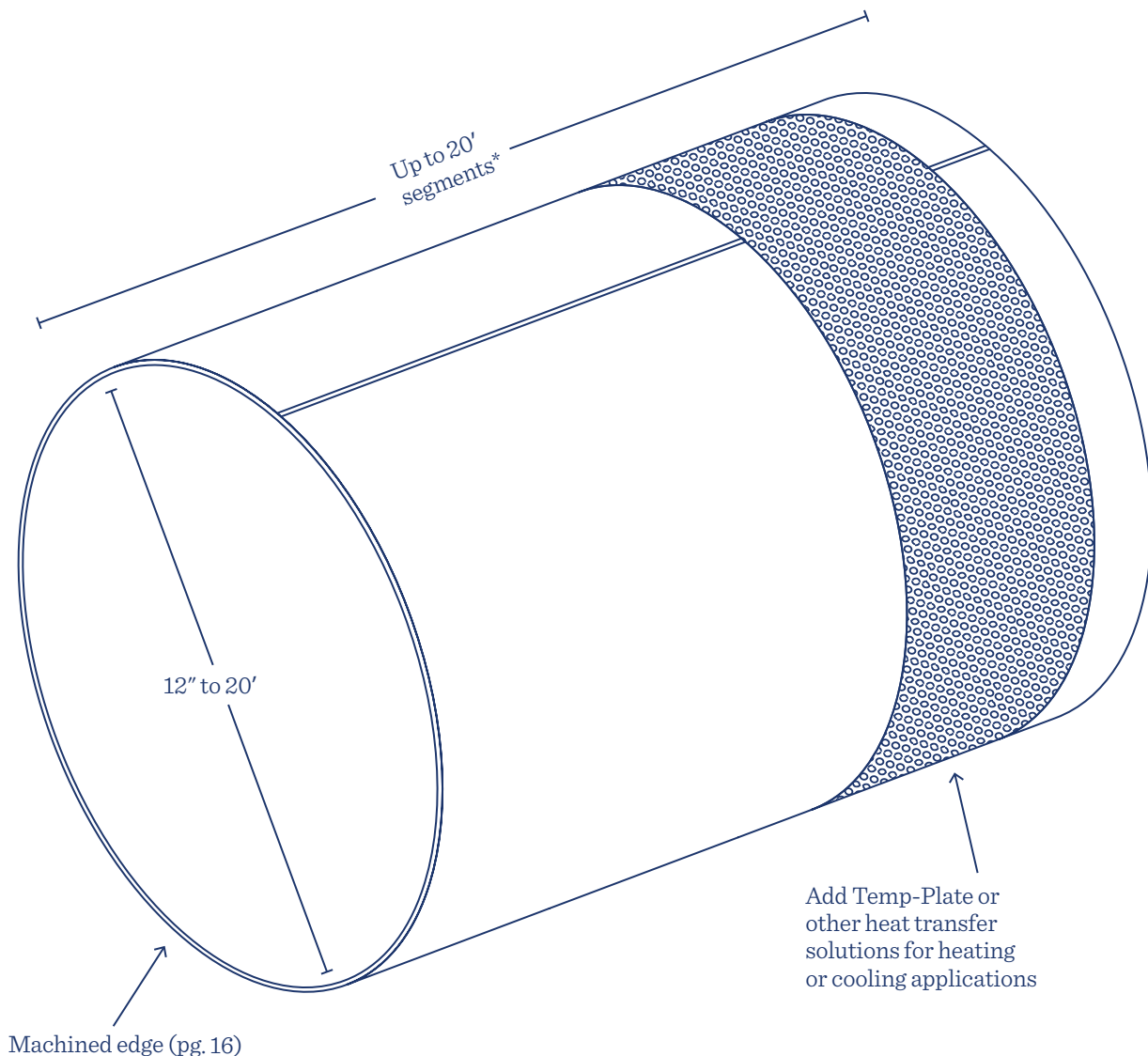

\* Multiple segments can be circumferentially welded together to meet your custom shell requirements.



# Tolerances and Allowances

## Circumference and Overall Height

The following tolerances apply to all typical flanged and dished heads. For typical head types, see page 13.

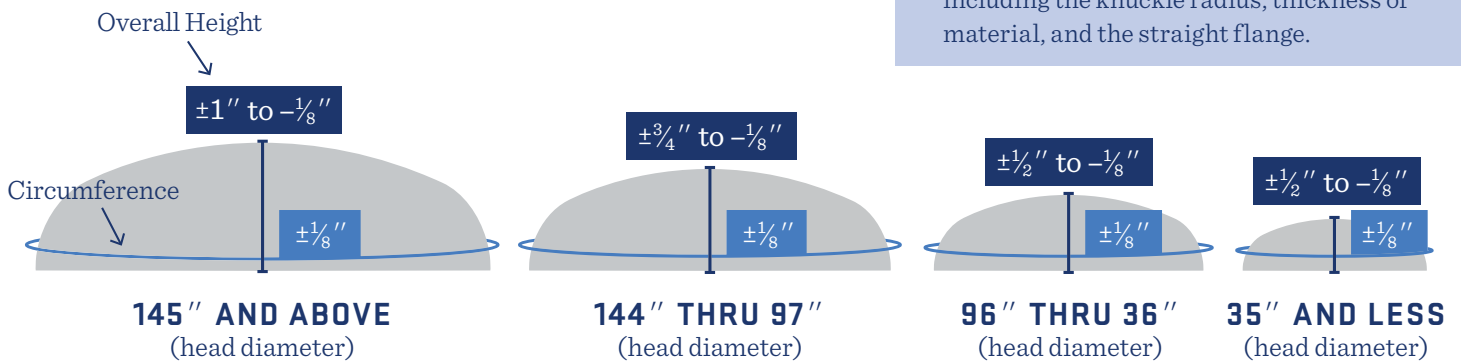

**OVERALL HEIGHT (OAH):**  
This is the height of the head at its center, including the knuckle radius, thickness of material, and the straight flange.

## Straight Flange

Both straight flange and overall height cannot be held simultaneously. Heads will be trimmed to comply with overall depth tolerances, as long as minimum straight flange is held as follows:

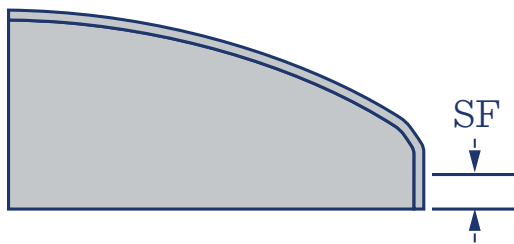

Standard Straight Flange: One inch for heads less than 48" in diameter and 1.5" for heads greater than or equal to 48" in diameter.

### STRAIGHT FLANGE (SF):

Flanges up to 3" can be supplied on some heads, providing material thickness is suitable.

## Edge Machining Types\*

-  SQUARE EDGE
-  SINGLE BEVEL ID/OD
-  SINGLE BEVEL WITH LAND ZONE ID/OD
-  DOUBLE BEVEL
-  DOUBLE BEVEL WITH LAND ZONE
-  SINGLE BEVEL WITH LAND ZONE AND 3:1 TAPER ID/OD
-  DOUBLE BEVEL WITH LAND ZONE AND 3:1 TAPER

\* Call for custom edge machining types.

# Tolerances and Allowances

## Forming Allowances

Minimum thickness of material after forming, but not including polishing, for typical flanged and dished heads:

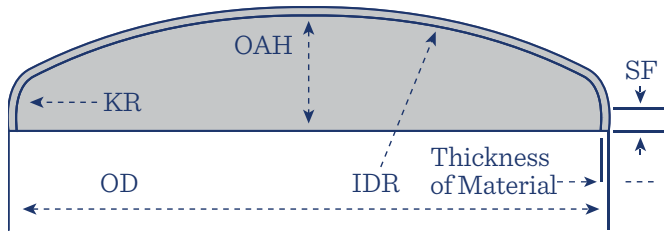

### ASME FLANGED AND DISHED FORMING ALLOWANCES

Diameter: 16" to 300"

1/2" Thick or Less: .03125"

Greater than 1/2" Thick:

15% of the minimum thickness

### KNUCKLE RADIUS (KR):

The radius formed during the flanging process. ASME flanged and dished heads must have a KR greater than or equal to 6% of the head's OD.

### INSIDE DISH RADIUS (IDR):

The radius formed during the dishing process. ASME flanged and dished heads must have a IDR less than or equal to 100% of the head's OD.

*For custom flanged and dished, toriconical, or other designs with special order geometry, please contact your sales representative for minimum thickness after forming.*

## Grinding Allowances

Due to the custom nature of fabricating components, we recommend contacting your Mueller Sales Representative to review your specifications and assess an agreed upon final nominal thickness with your quote.

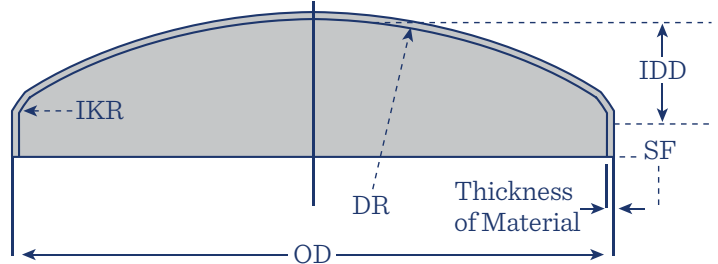

### 80:10 FLANGED AND DISHED FORMING ALLOWANCES

Diameter: 20" to 220"

1/2" Thick or Less: .0625"

Greater than 1/2" Thick:

15% of the minimum thickness

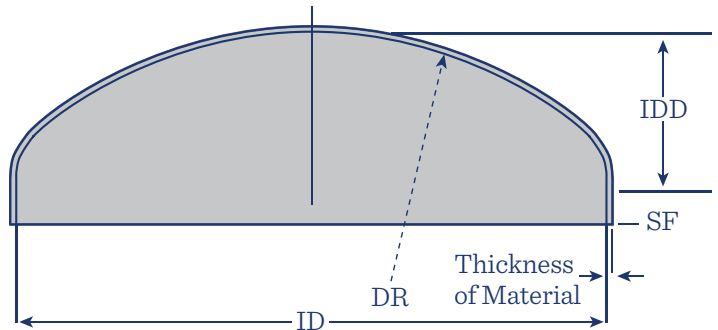

### 2:1 ELLIPTICAL FLANGED AND DISHED FORMING ALLOWANCES

Diameter: 20" to 144"

1/2" Thick or Less: .0625"

Greater than 1/2" Thick:

15% of the minimum thickness

# Tolerances and Allowances

## Reverse Dish Tolerances

Typical dished and flanged heads shall have a tolerance for maximum reversed condition as follows:

### REVERSE DISH:

The amount of deviation towards the center of the head where the dish radius meets the knuckle radius.

 $\frac{1}{4}''$ 

**145" AND ABOVE**  
(head diameter)

 $\frac{3}{16}''$ 

**144" THRU 101"**  
(head diameter)

 $\frac{1}{8}''$ 

**100" THRU 0"**  
(head diameter)

### FLARED AND DISHED HEADS

Outside Diameter:  $-0''$  to  $+\frac{1}{2}''$

Inside Diameter:  $\pm\frac{1}{4}''^*$

Out-of-Round: Not to exceed 1% of OD

\* Inside diameter tolerance is for reference only.

### DISHED-ONLY HEADS

Outside Diameter:  $-0''$  to  $+\frac{1}{2}''$

Inside Diameter:  $\pm\frac{1}{4}''^*$

Out-of-Round: Not to exceed 1% of OD

\* Inside diameter tolerance is for reference only.



## Flanged-Only Head Flatness Tolerance

Flanged-only heads shall have a  $\pm\frac{1}{8}''$  circumference tolerance. Some warping of the flat portion may be expected depending on diameter, material thickness, and knuckle radius.

 $\pm\frac{1}{2}''$ 

**120" THRU 96"**  
(head diameter)

 $\pm\frac{1}{4}''$ 

**95" THRU 61"**  
(head diameter)

 $\pm\frac{3}{16}''$ 

**60" THRU 0"**  
(head diameter)

Flanged-only head flatness tolerances do not apply to heads with weld seams.

# Component Products FAQs

## Frequently Asked Questions

Below you will find a list of frequent questions about Component Products. If your question is not listed, you can always give us a call at 1-800-545-5224 for further assistance.



**Paul Mueller Company builds tanks. Why would I buy from my competition?**



Let us use our vast knowledge, heritage, and craftsmanship to bring value to your vessel fabrication project. Building tanks is only one manufacturing task of many that Paul Mueller Company offers. As a stand-alone business unit, Component Products is here to provide you with high-quality tank component solutions at a competitive price. Ask yourself, why should I buy components from someone who does not have tank fabrication experience?



**I heard you have a web store. How do I make purchases or view items online?**



Go to [shop.paulmueller.com](http://shop.paulmueller.com) and click on the register button in the top right-hand corner to create an account. Use the search bar or web store menu to search for specific items, add to your cart, and check out when finished. We also offer easy online payment options including credit card payment or purchase order approval depending on your credit terms with Mueller. If you require any web store assistance, please contact us at 1-800-545-5224.



**What shipment solutions can Mueller Component Products offer me?**



In addition to standard shipping options, we are proud to offer services by Mueller Transportation, Inc (MTI). MTI is a wholly-owned subsidiary of Paul Mueller Company that is tasked with delivering Mueller-fabricated equipment. We provide specialty freight from our floor to your door. MTI is not a freight forwarder, but a freight provider and supports all of our freight requirements from the routine to the extreme. Safe, timely, professional, well-equipped, and clearly executed.



## **Q Where do I find the serial number on Mueller-fabricated equipment?**

**A** Serial numbers for Mueller-fabricated equipment can be located on the Mueller data plate or permanently stamped on the manway hinge lug, the agitator support truss, or the support legs and lugs. Data plate and permanent stamping locations may vary slightly from product to product. If you are having trouble locating your serial number, contact your Mueller Sales Representative.

## **Q How can I access 3-D manway models for use in my own vessel drawings?**

**A** Log on to the Paul Mueller Company web store with the same account you use to purchase components and parts. Contact us at 1-800-545-5224 and we will turn on your access to 3-D models. All models are .IGS files and are compatible with Inventor, SolidWorks, and ProE. To download the models, drop them into your assembly drawing and then purchase the part; you will have a simple path to obtain the components required to finish your project.

Still not sure we can build your tank components? Chances are we have your solution. You may have some pretty interesting projects going in your shop. There is a good chance we have ready-built or customizable components to fit your specific project needs. Give us a call with your toughest cases today!





# PAUL MUELLER COMPANY



**PAUL MUELLER, OUR FOUNDER**

At Paul Mueller Company, we are united by a belief that the only quality that matters is quality that works for life. With every piece of processing equipment we build, our goal is to have lasting impact. This collective vision has led us from a small sheet metal shop to a global supplier of heating, cooling, processing, and storage solutions. Our equipment allows farmers, food producers, and engineers to keep their products fresh and their inventory strong. Whether our equipment is a small piece in your big picture or the critical component for your final product, together we are making an impact across the globe.



[contact@paulmueller.com](mailto:contact@paulmueller.com)

**1-800-MUELLER | PAULMUELLER.COM**

©2019 Paul Mueller Company | 17353 | TH-714-9